

Einbauanleitung Lyon 1/4 gewendelt oben mit senkrechten Stäben

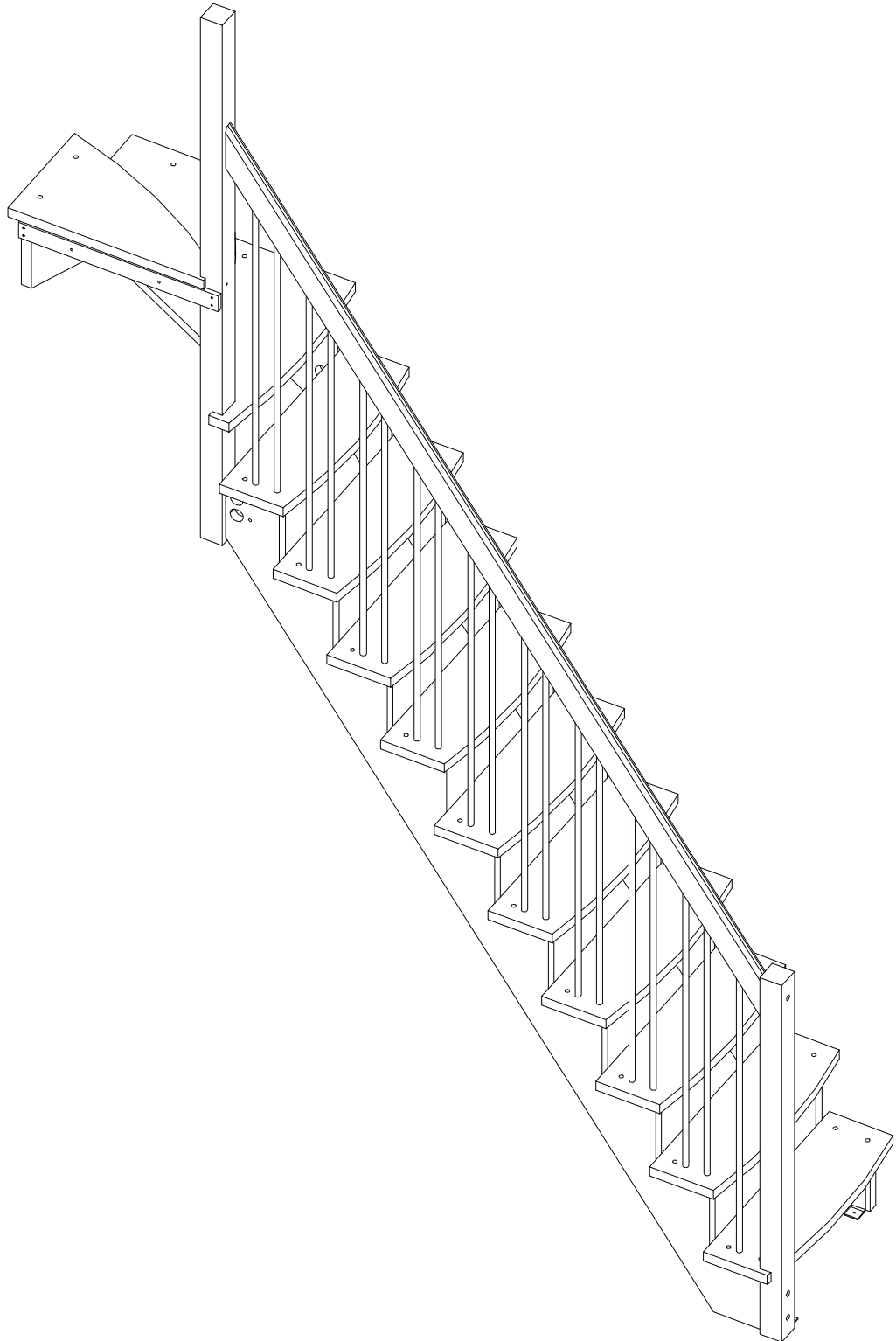

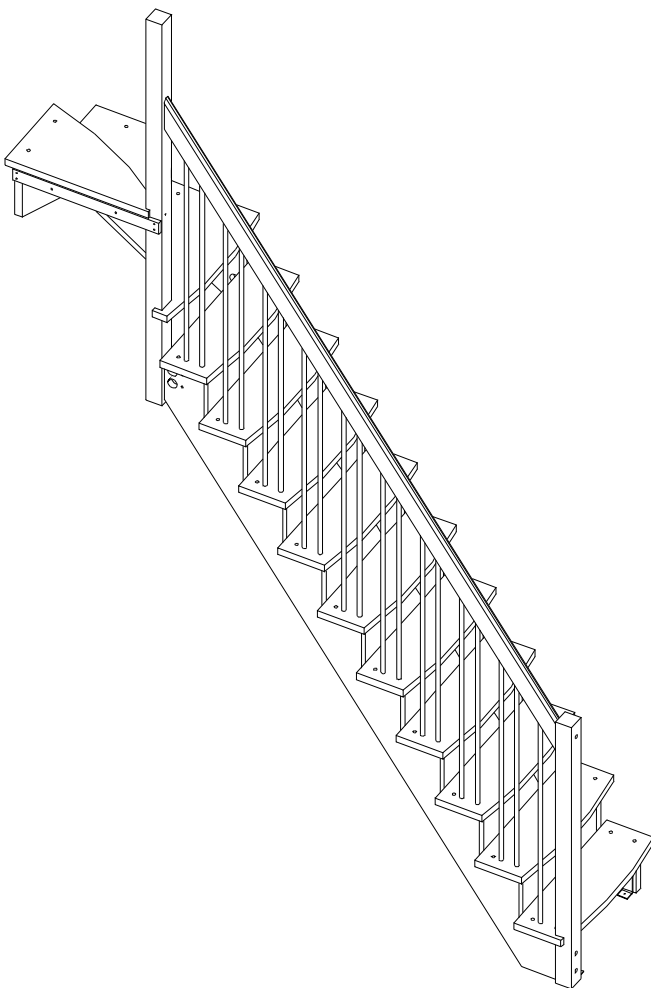





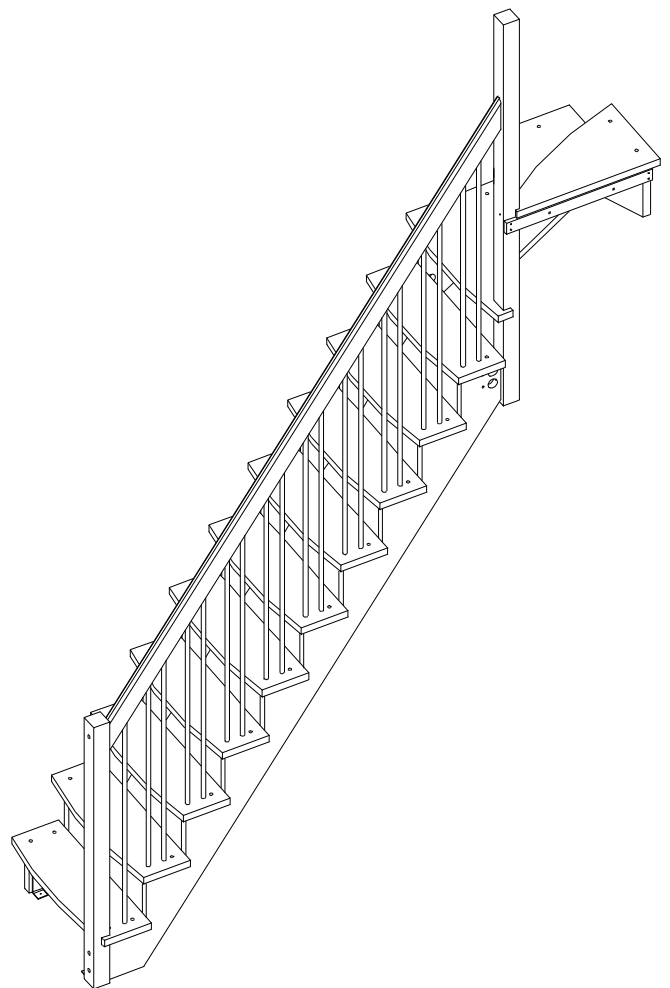

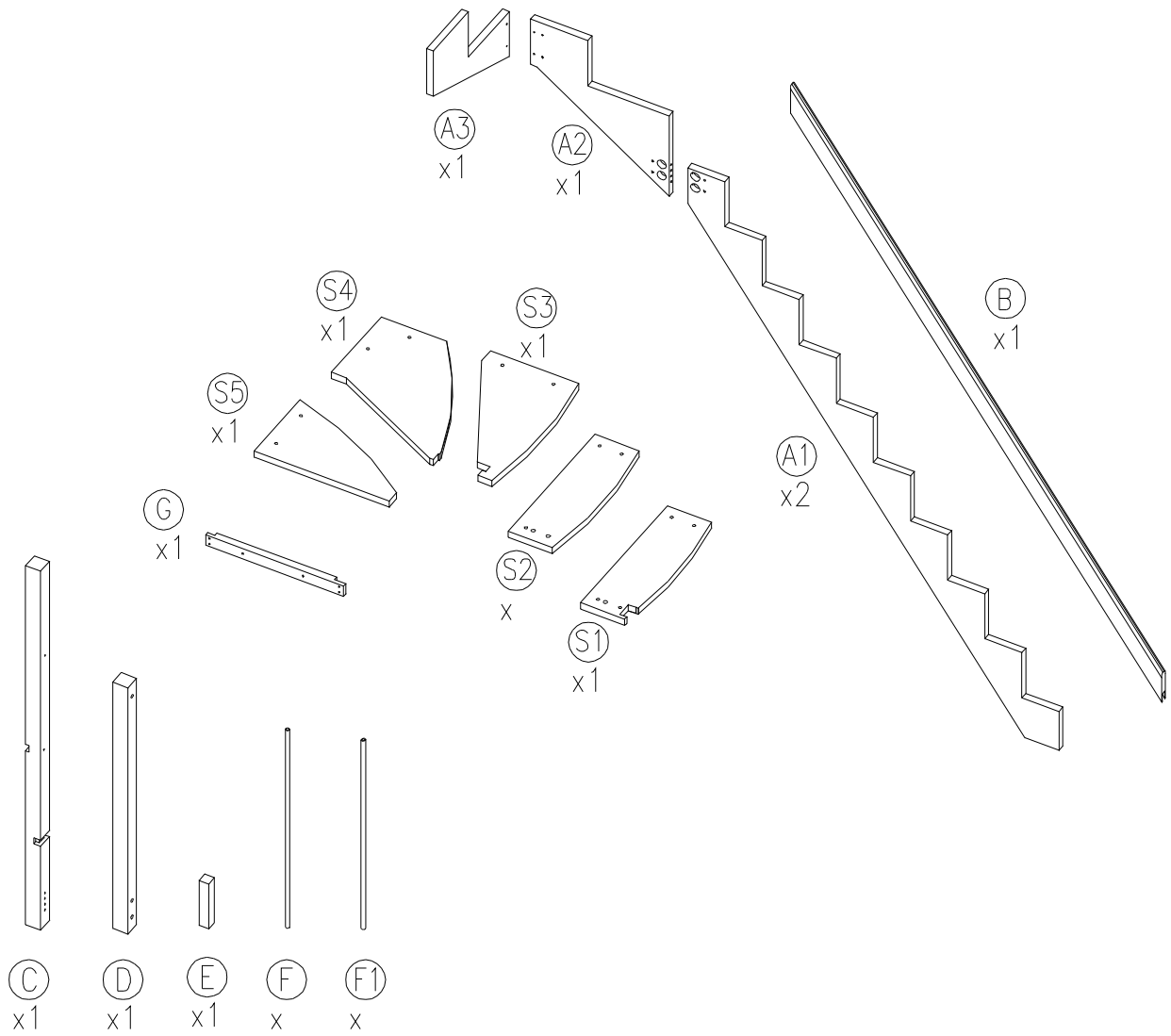





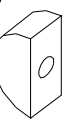







Laufrichtung
Abb.: Linkslaufend

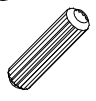

Laufrichtung
Abb.: Rechtslaufend

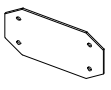



 ① x2 6x50	 ② x4 10x50	 ③ x4 4,5x20	 ④ x2 \varnothing 8x55	 ⑤ x6	 ⑥ x10 M8	 ⑦ x14 6x70	 ⑧ x2 \varnothing 8/ \varnothing 24	
 ⑨ x8 \varnothing 8	 ⑩ x37 \varnothing 12	 ⑪ x50 5x50	 ⑫ x10 \varnothing 40	 ⑬ x2 M8x70	 ⑭ x2	⑮	⑯	
 ⑰ x1	 ⑱ x10 \varnothing 8	 ⑲ x4 \varnothing 10	 ⑳ x1	 ㉑ x1	 ㉒ x4 M8x40	 ㉓ x2	 ㉔ x2 14x135	 ㉕ x2 10x140

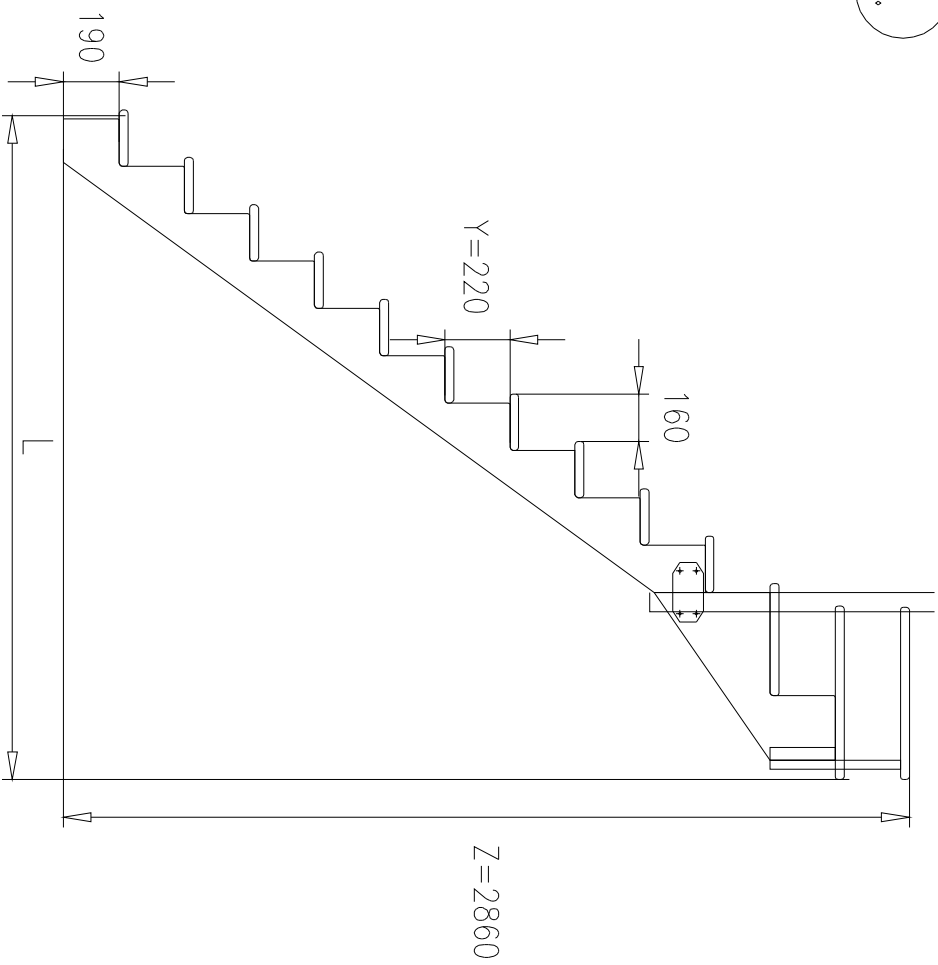
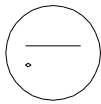

Y Steigung	Z Höhe
22.0 cm	
Stufen	
11	242.0 cm
12	264.0 cm
13	286.0 cm

Stufen	Y Steigung 22.0 cm	
	L Ausladung	
11	65.0 cm	75.0 cm
11	197	207
12	213	223
13	229	239

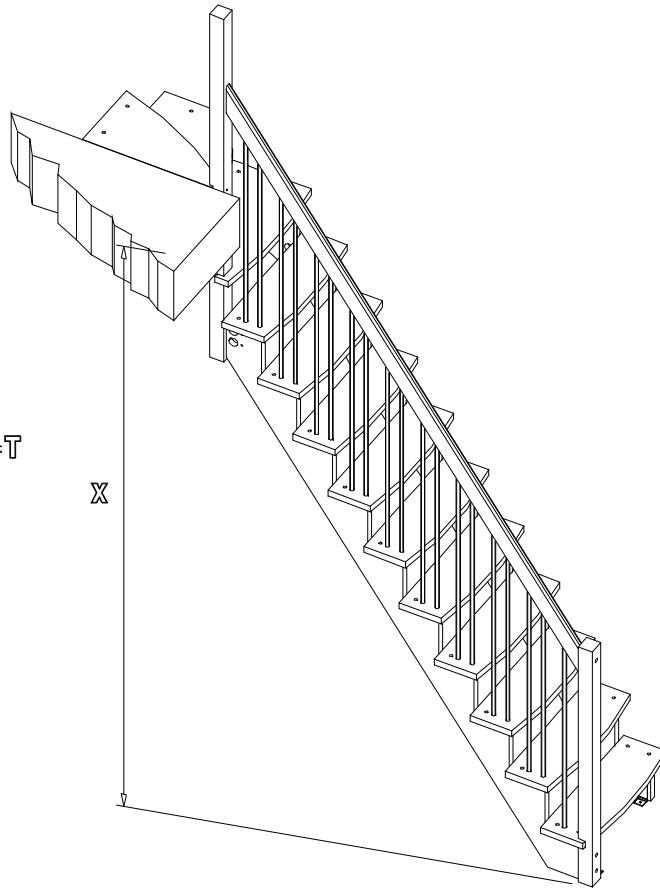

1

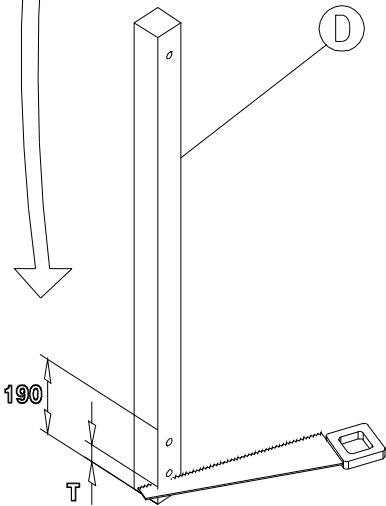

2

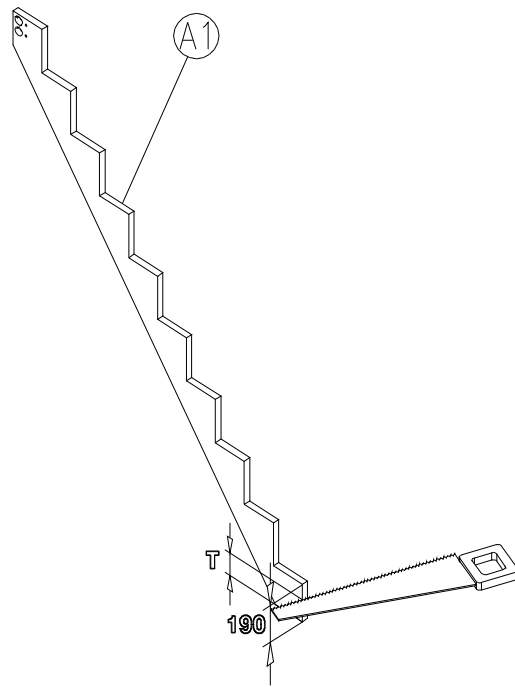

3

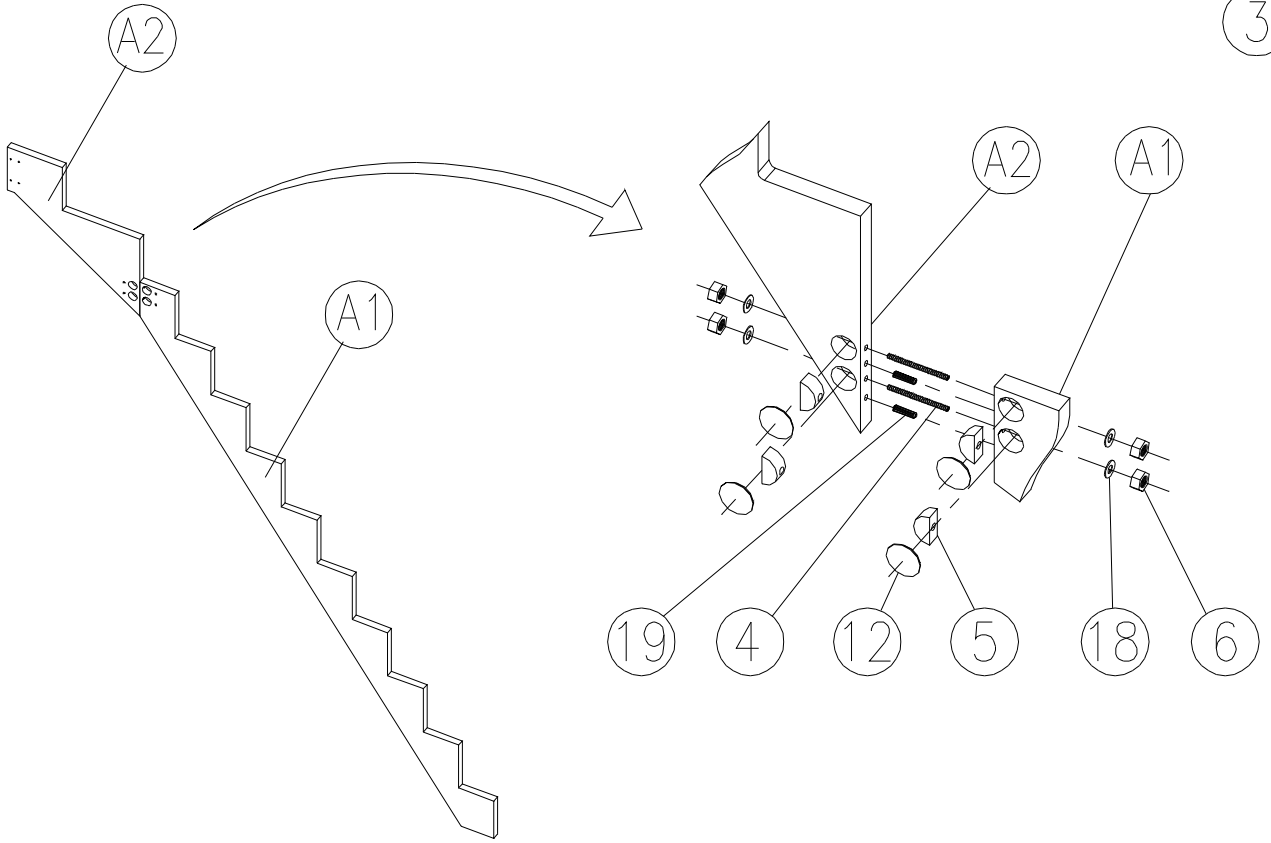

4

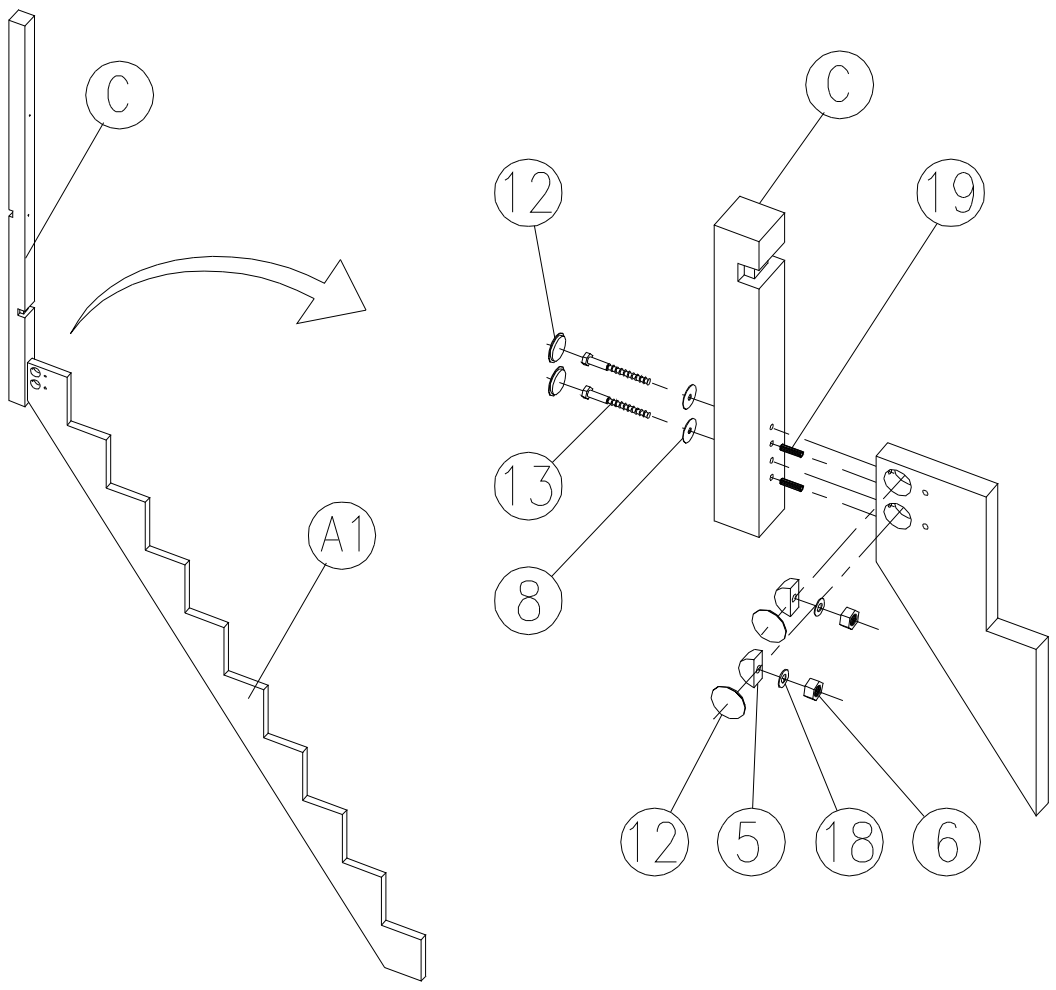

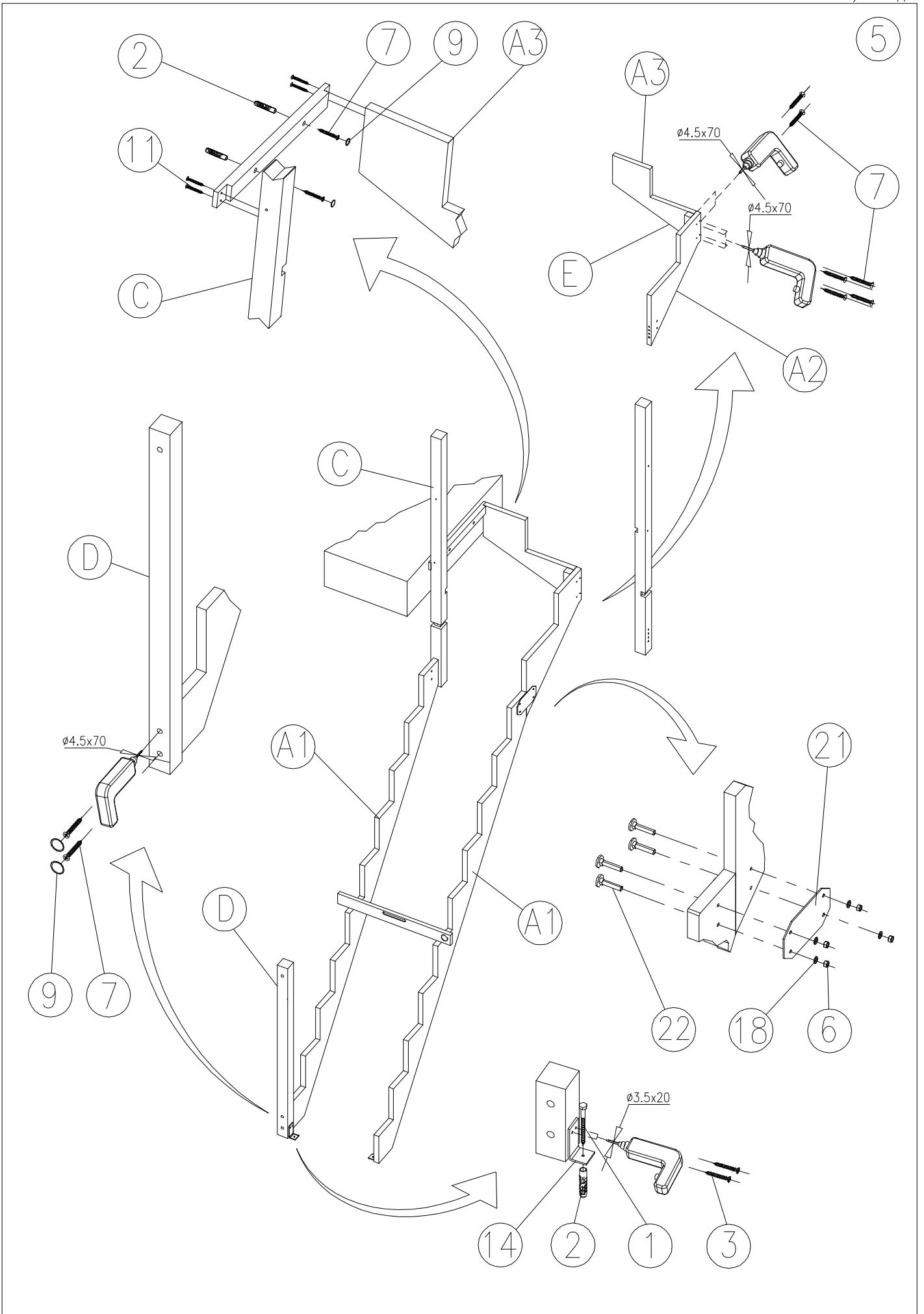

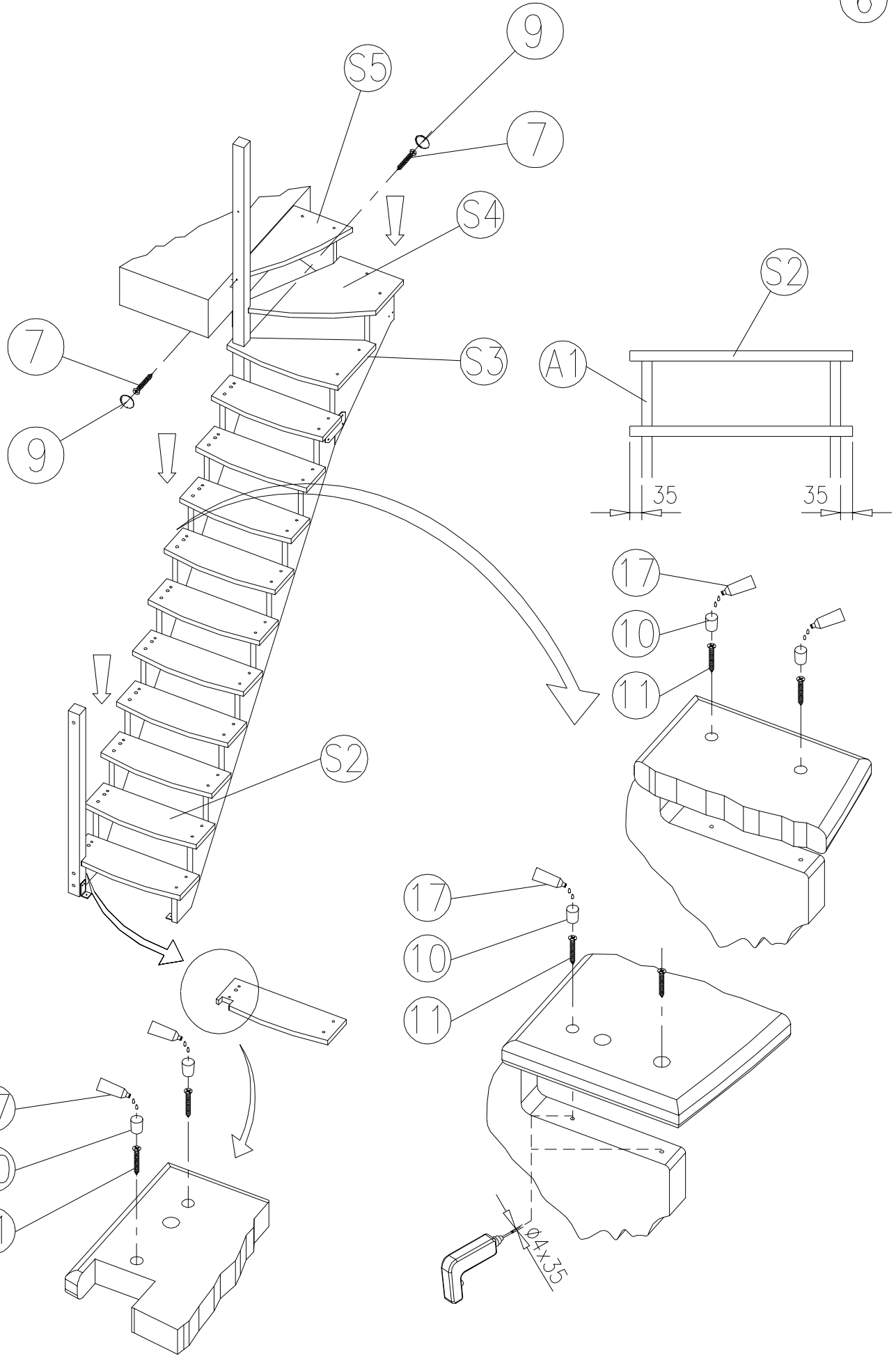

7

