

Einbauanleitung Lyon 1/4 gewandelt oben mit mitlaufenden Edelstahlstäben

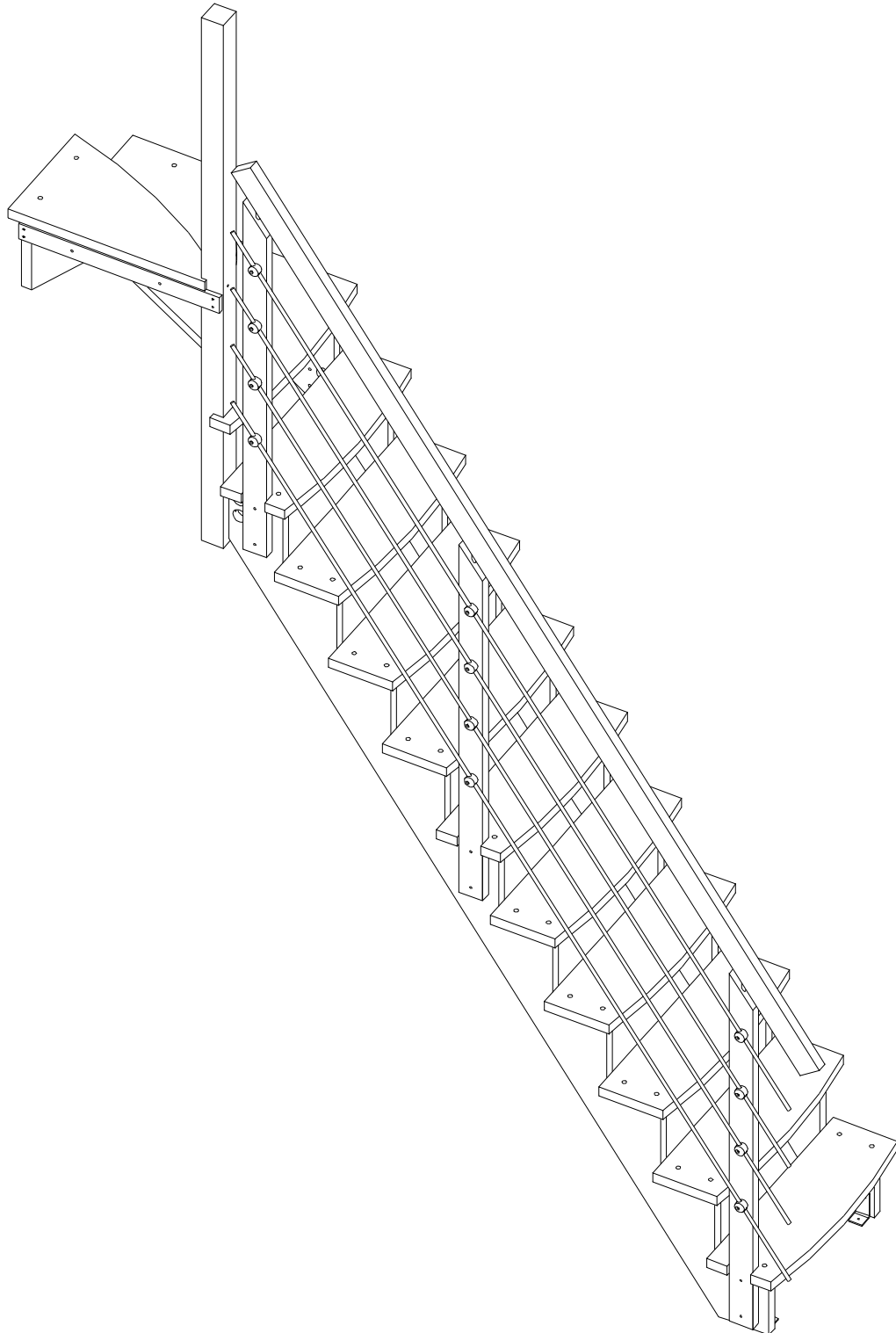

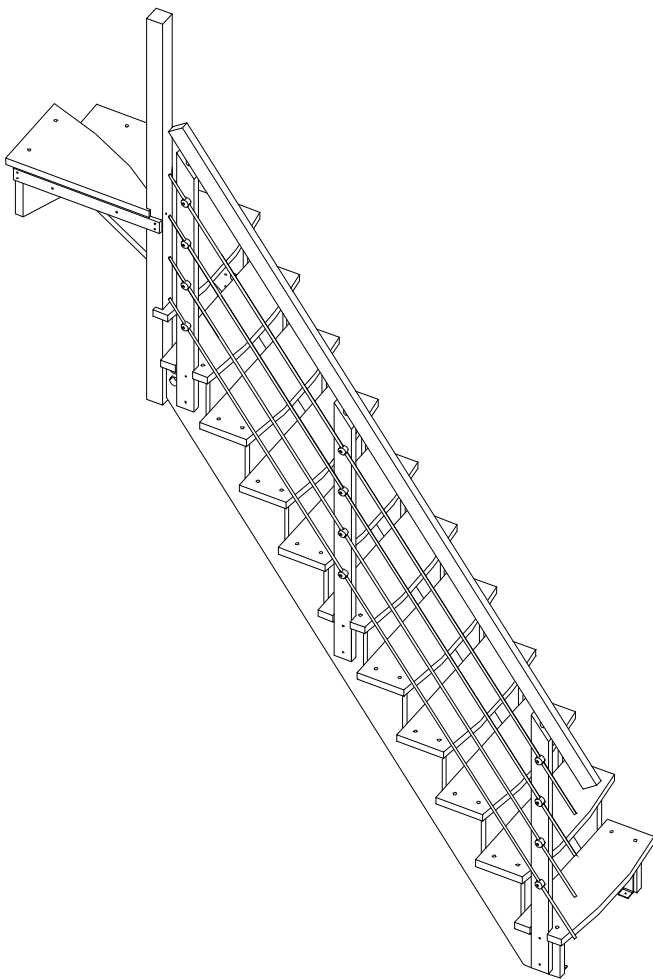





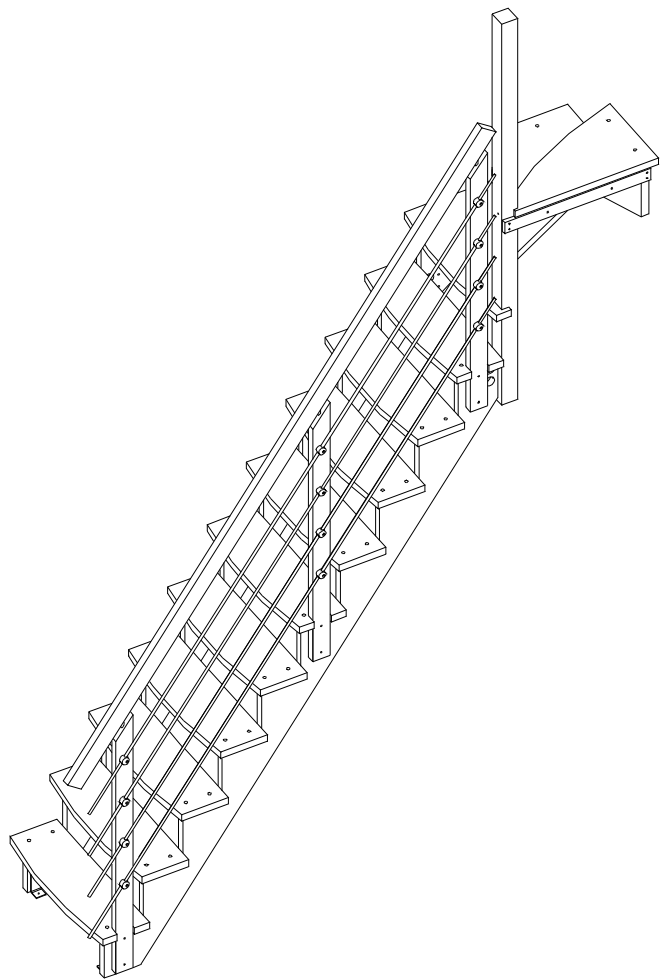

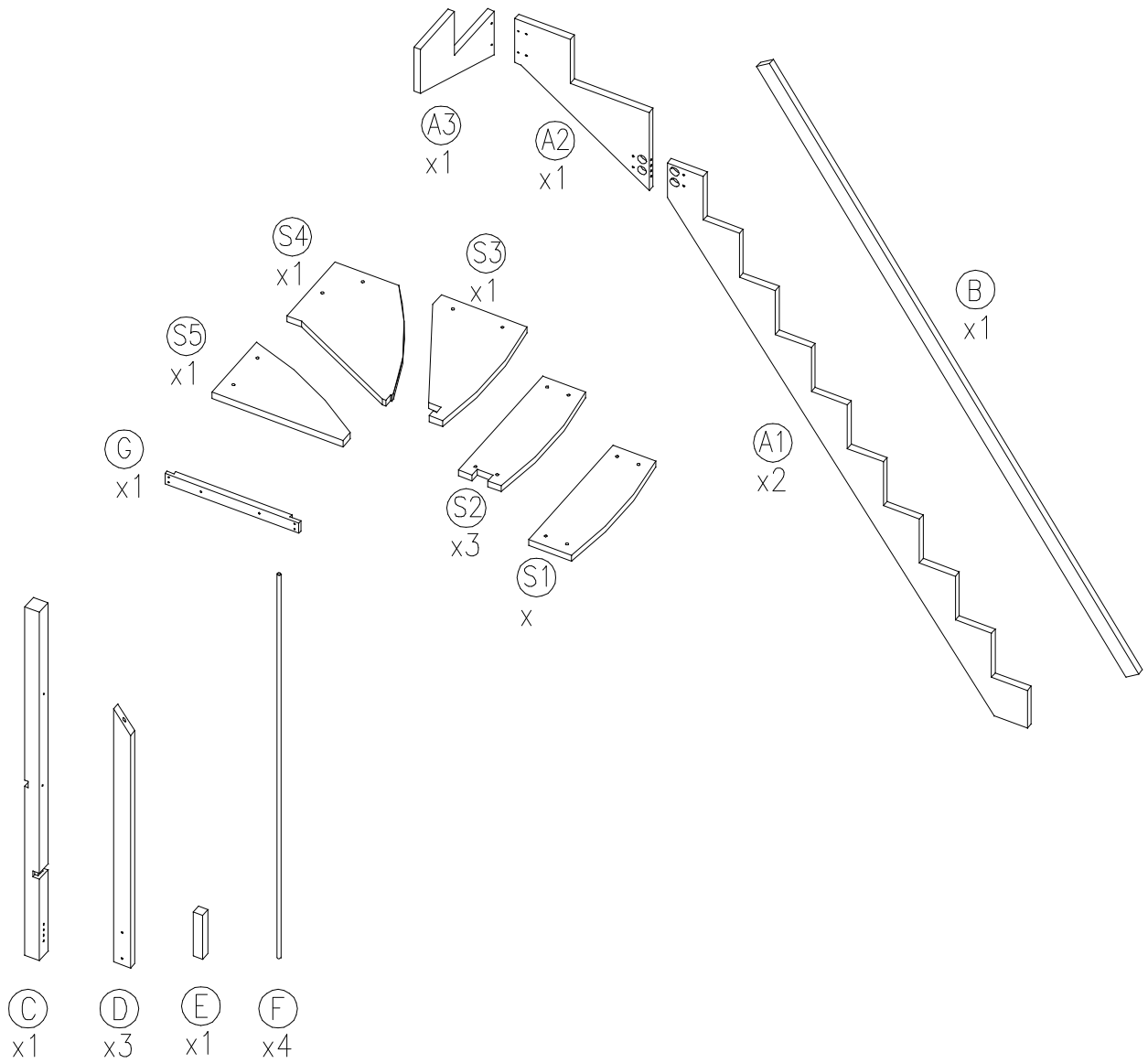









Laufrichtung
Abb.: Linkslaufend



Laufrichtung
Abb.: Rechtslaufend



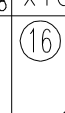

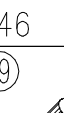
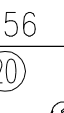
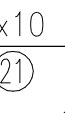
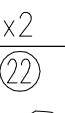
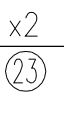
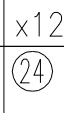
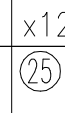
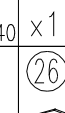
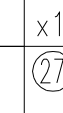
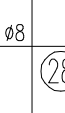
 ① x2 6x50	 ② x4 10x50	 ③ x4 4,5x20	 ④ x2 ø8x55	 ⑤ x6	 ⑥ x10 M8	 ⑦ x10 6x70	 ⑧ x2 ø8/ø24	 ⑨ x4 ø16	
 ⑩ x46 ø12	 ⑪ x56 5x50	 ⑫ x10 ø40	 ⑬ x2 M8x70	 ⑭ x2	 ⑮ x12	 ⑯ x12 4.5x40	 ⑰ x1	 ⑱ x10 ø8	
 ⑲ x4 ø10	 ⑳ x1	 ㉑ x3 ø10x148	 ㉒ x6	 ㉓ x2 ø30	 ㉔ x2 ø14x135	 ㉕ x2 ø10x140	 ㉖ x1	 ㉗ x4 M8x40	 ㉘ x8

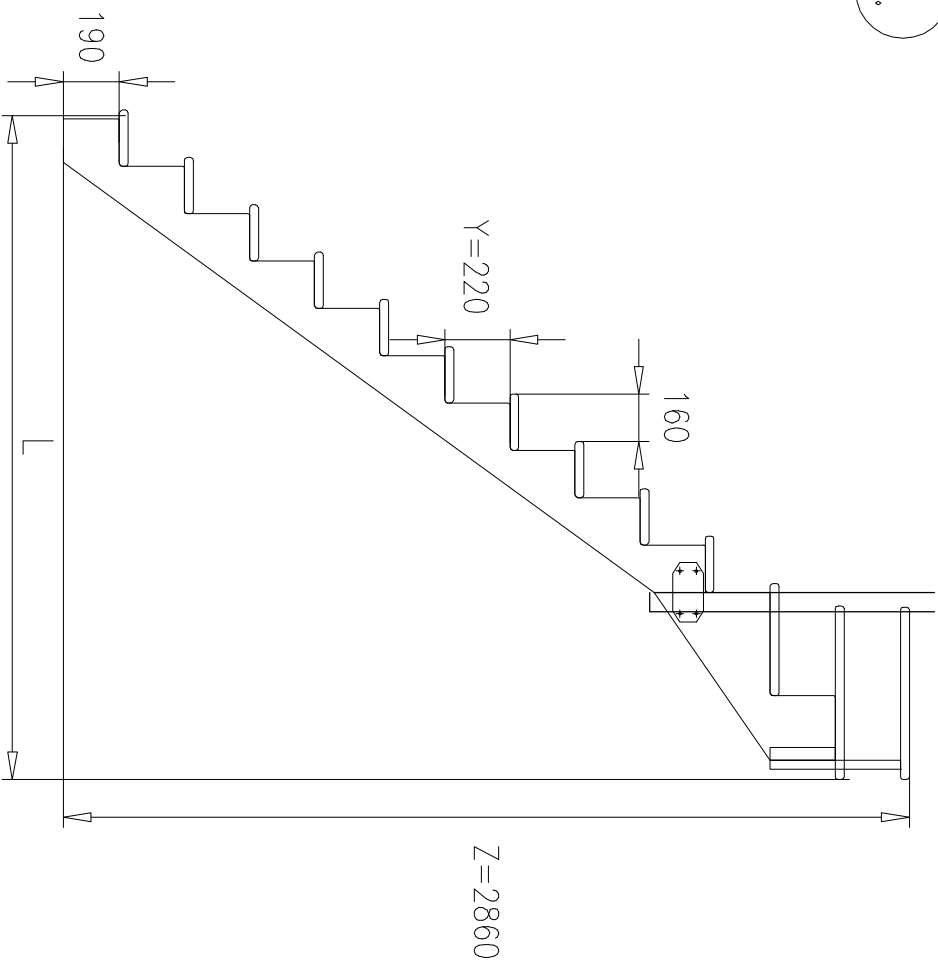
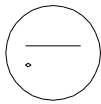

Y Steigung	Z Höhe
22.0 cm	
Stufen	
11	242.0 cm
12	264.0 cm
13	286.0 cm

Y Steigung 22.0 cm		
Stufen	L Ausladung	
	65.0 cm	75.0 cm
11	197	207
12	213	223
13	229	239

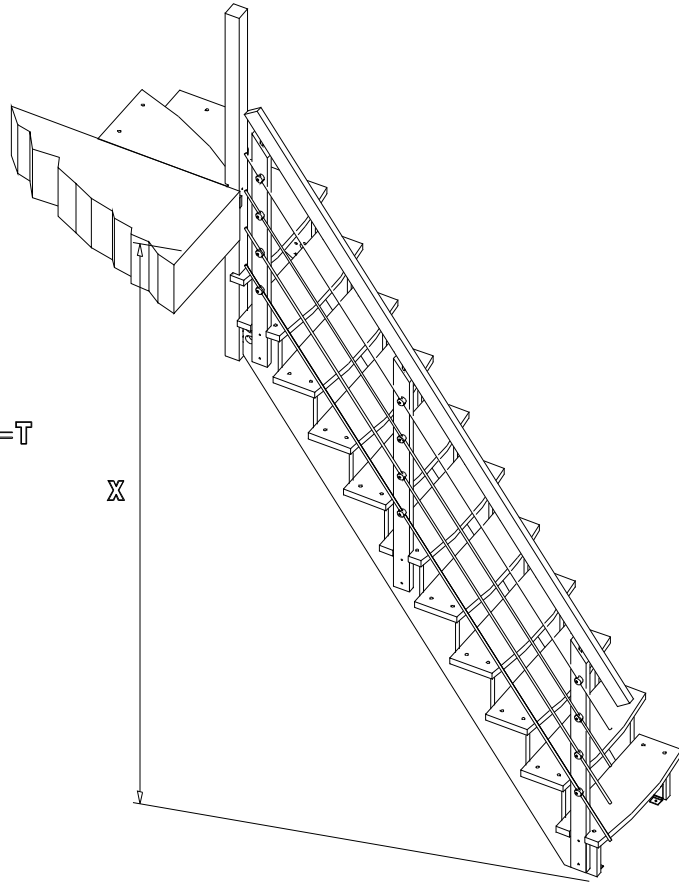

1

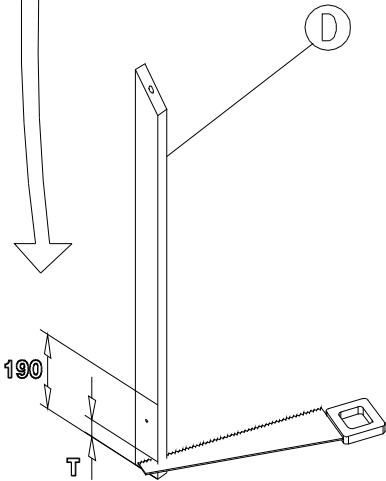

2

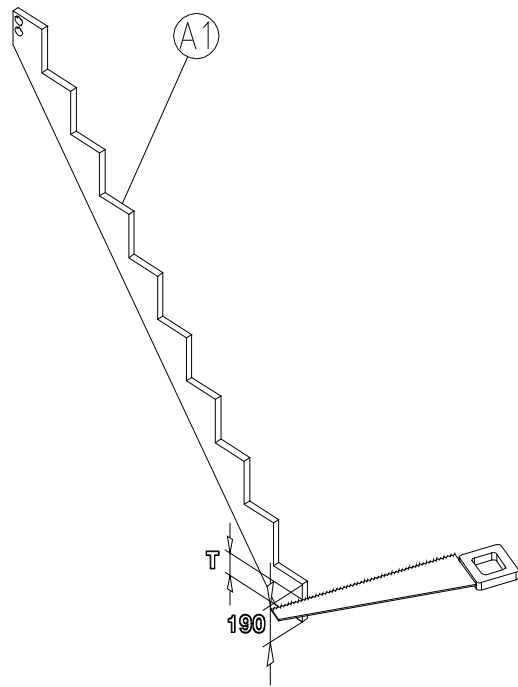

3

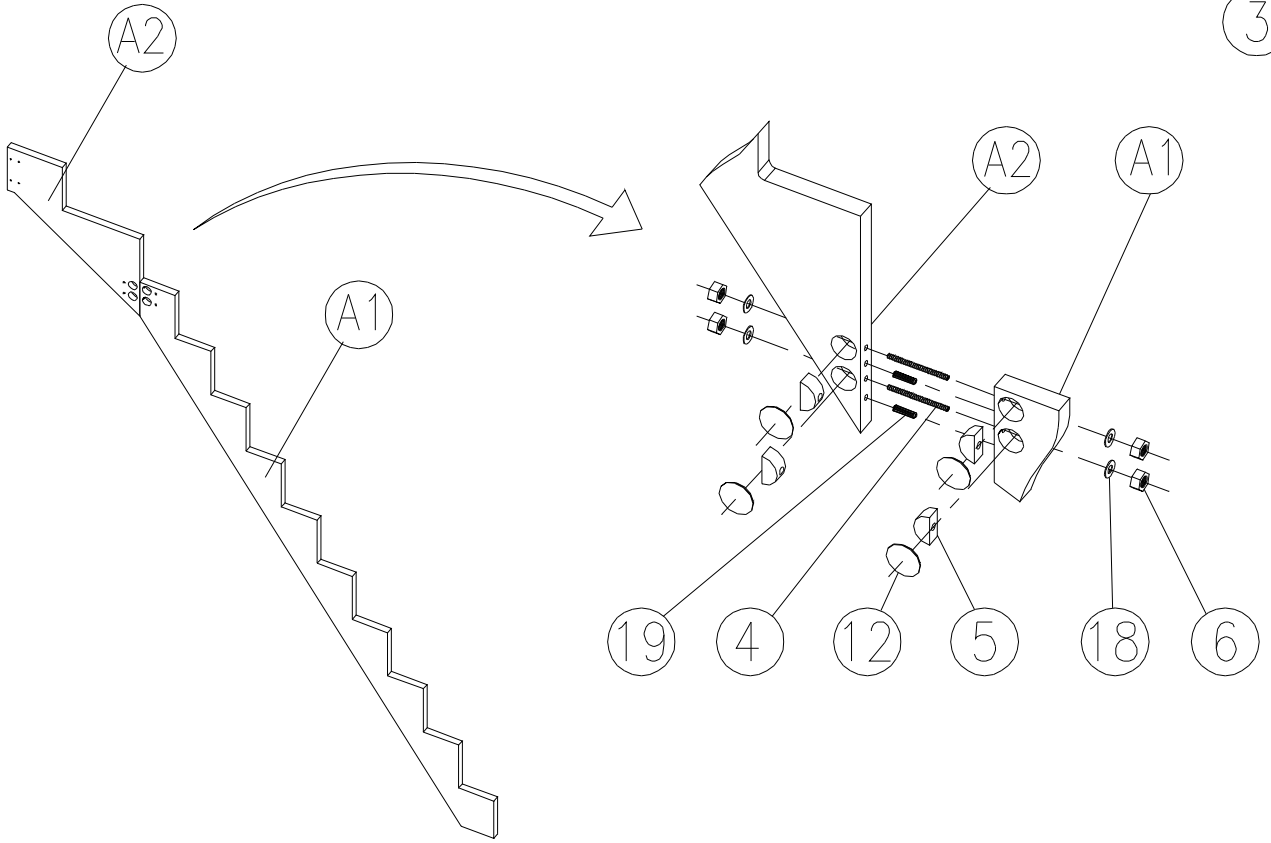

4

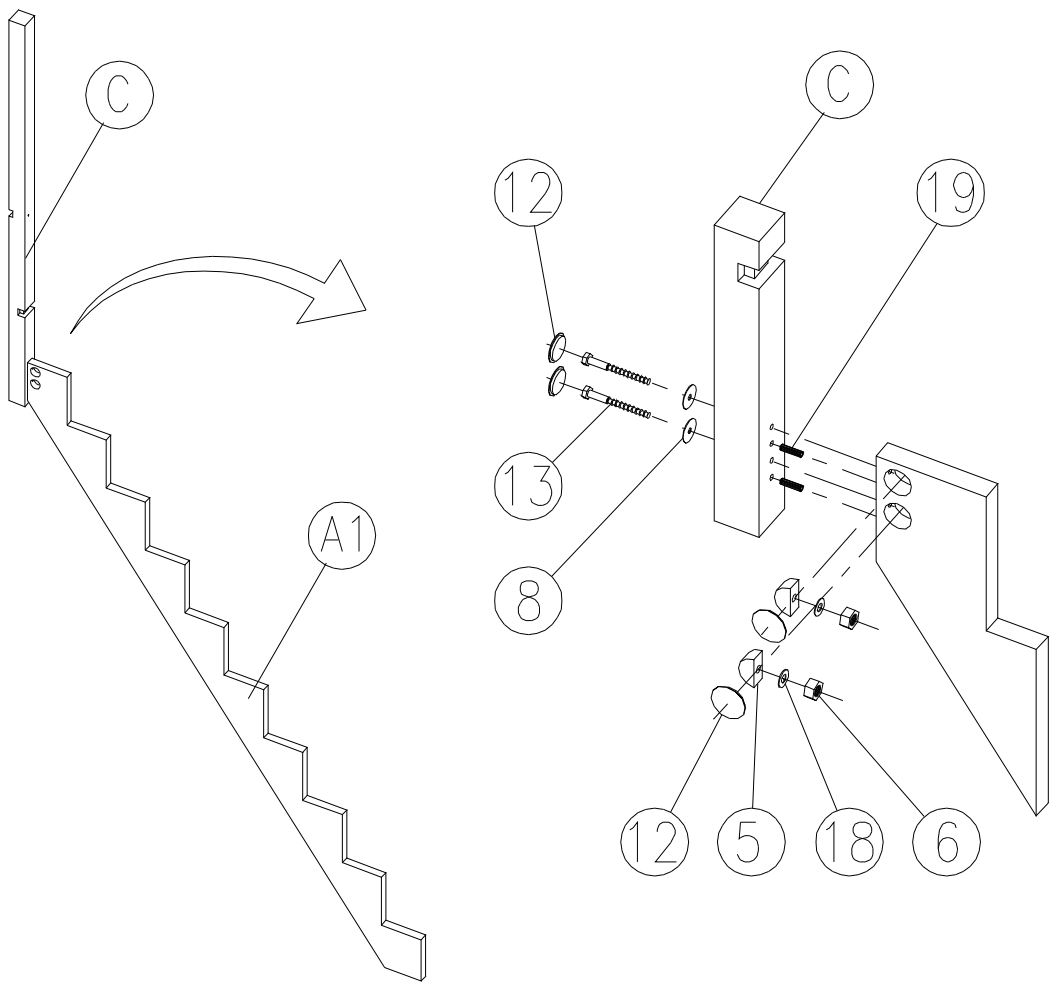

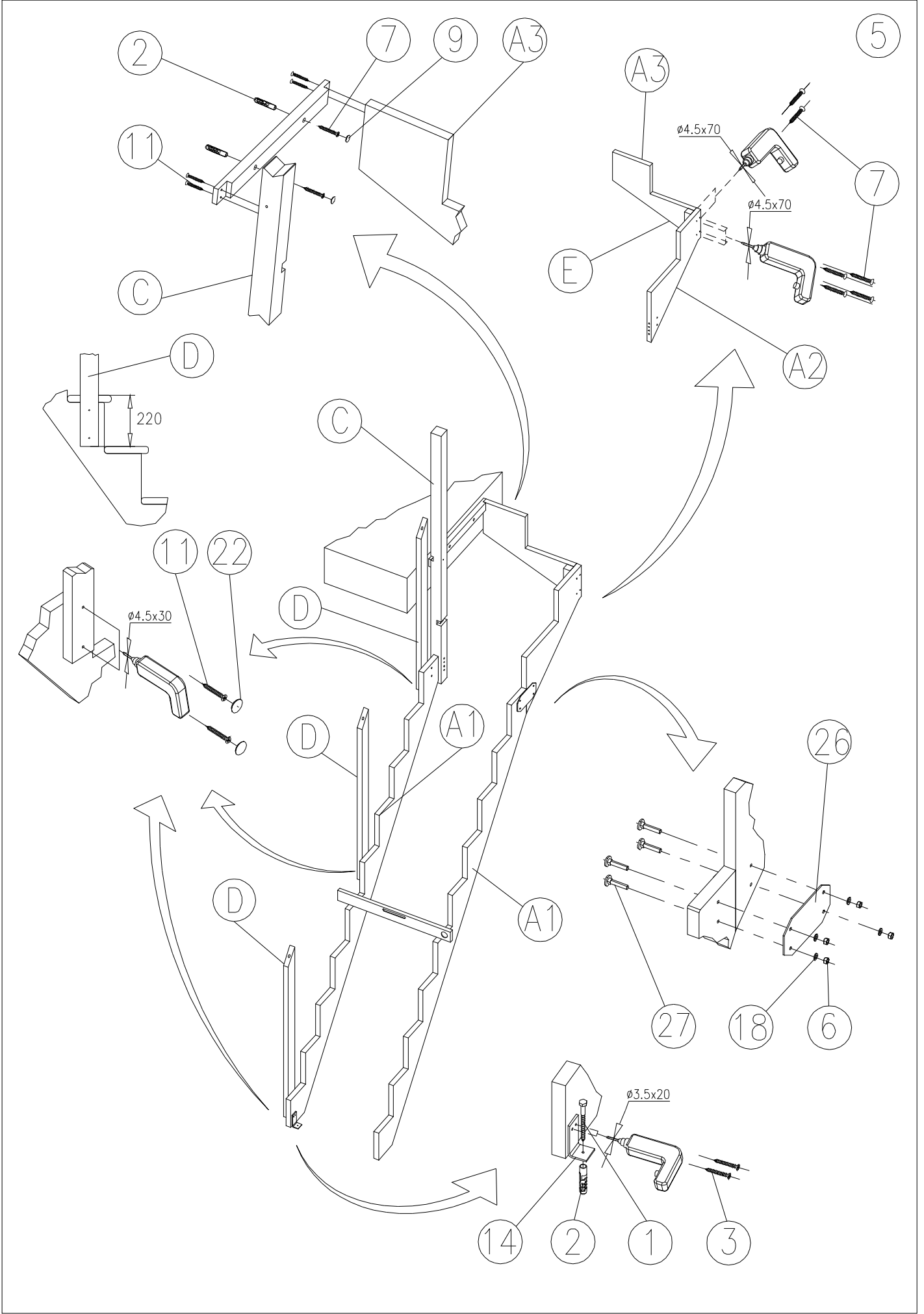

6

